

Erbium/Ytterbium Doped Fiber Amplifier

1528-1563nm & 1570-1603nm, up to 26dBm



DATASHEET

[Return to the Webpage](#)



Agiltron Erbium/Ytterbium-doped fiber amplifiers (EDFA) extend the short wavelength range and provide cost-effective solutions for high-power optical amplification. It is built using semiconductor lasers, WDM, isolator, and erbium and ytterbium co-doped fiber. The product has the advantages of high reliability, high power output, high gain, and low noise. Two configurations are available: A preamplifier for slight optical signal amplification and a Booster amplifier for maximum output power. We make both random polarization and polarization maintaining versions. It has several package configuration choices. A Benchtop unit that is preset at the highest gain is suited for laboratory use. The Benchtop has a computer control interface and GUI. The compact module is suited for system integration with the universal control interface. The pluggable and the associated host net-control rack are standardized for local network build-out. Customer configurations are available.

The EDFA has isolators on both input and output.

These Erbium-Doped Fiber Amplifiers (EDFAs) are engineered for a long operational lifespan, typically designed to function reliably for over 10 years. This durability is achieved through high-quality components and robust manufacturing processes. The design considerations include thermal management, component selection, and rigorous testing to maximize the amplifier's longevity and efficiency.

Features

- Low Noise
- High Output Up to 41dBm
- High Stability
- High Reliability
- Customizable

Applications

- BOTDR
- OTDR
- LiDAR
- Fiber sensing

Specifications

Parameter	Min	Typical	Max	Unit		
Wavelength	1530	1550	1610	nm		
Input Power	Booster Amplifier		-6	0	3	dBm
Saturated Output Power ^[1]	15		26	dBm		
Gain Range ^[3]	13		26	dB		
Noise Index			5	dB		
Gain Flatness		3		dB		
Polarization Dependent Gain ^[4]			0.3	dB		
Polarization Mode Dispersion ^[4]		0.5				
Polarization Extinction Ratio ^[5]	18		20	dB		
Input/output Isolation	35			dB		
Output Stability (8hrs)		0.05	0.1	dB		
Adjustable Output Power		Yes				
Fiber Type	SMF-28e 9/125um NA = 0.13					
Working Temperature ^[7]	-30		70	°C		
Storage Temperature	-40		85	°C		
Power Supply	DC +5V/GND					
Communication	>20dBm	RS232				
	<20dBm	USB				

Notes:

[1]. Maximum optical output power. For Booster type only

[3]. Amplification. Output power = Gain X Input power. For weak signals, buy a preamplifier

[4]. Random polarization version only

[5]. Polarization Maintaining only

[6]. Defined as $10\log(\text{SNR}_i/\text{SNR}_o)$

[7]. The regular range is -5 to 40°C, for extended range requires additional cost

* Preamplifier output power is limited to 25dBm

Legal notices: All product information is believed to be accurate and is subject to change without notice. Information contained herein shall legally bind Agiltron only if it is specifically incorporated into the terms and conditions of a sales agreement. Some specific combinations of options may not be available. The user assumes all risks and liability whatsoever in connection with the use of a product or its application.

Rev 11/15/24

© Photonwares Corporation

[+1 781-935-1200](tel:+17819351200)

sales@photonwares.com

www.agiltron.com

Information contained herein is deemed to be reliable and accurate as of the issue date. Photonwares reserves the right to change the design or specifications at any time without notice. Agiltron is a registered trademark of Photonwares Corporation in the U.S. and other countries.

Erbium/Ytterbium Doped Fiber Amplifier

1528-1563nm & 1570-1603nm, up to 26dBm



DATASHEET

Function Diagram

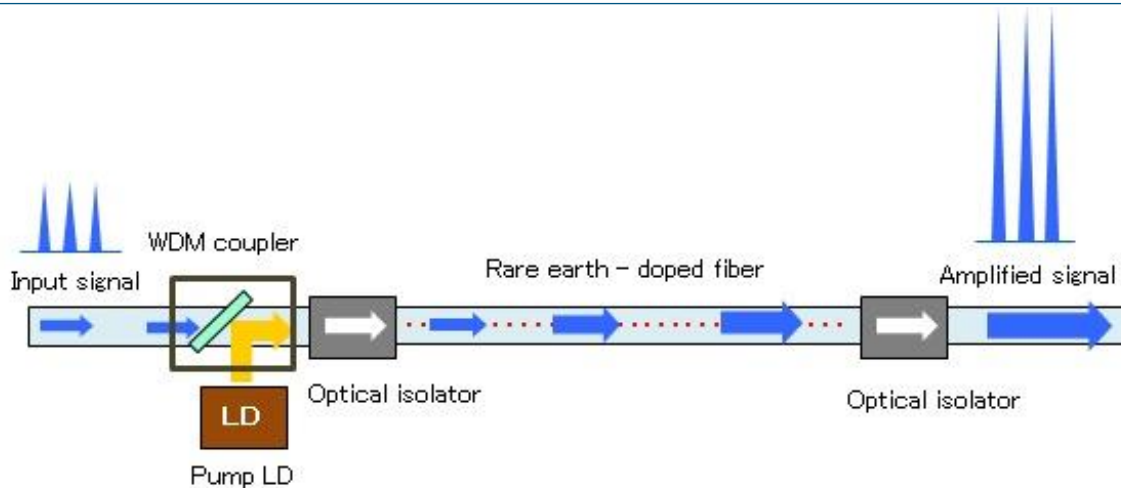

Package Choices



Component



Benchtop



Pluggable



Net-Control Rack

Erbium/Ytterbium Doped Fiber Amplifier

1528-1563nm & 1570-1603nm, up to 26dBm



DATASHEET

GUI USB Interface

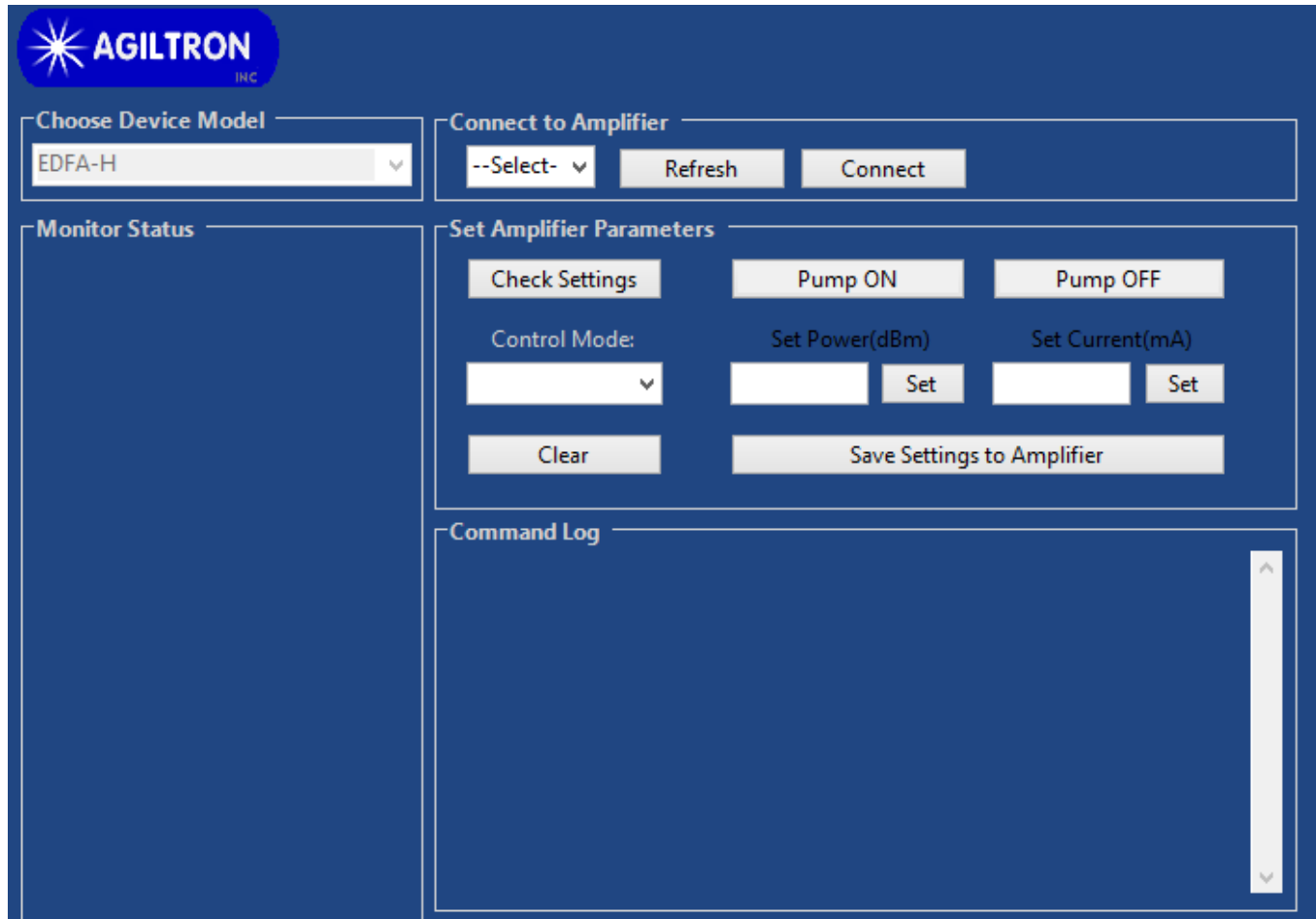

Operation Instruction

- Load the software, Unzip the folder and Click "setup" to Install the GUI
- Select an amplifier type that matches your PO
- Connect your PC to the Amplifier by first connecting a USB cable and then choosing the necessary port and clicking "Connect". To change the COM port click "Refresh", choose the necessary port, then click "Connect"
- Obtain the stored settings by clicking "Check Settings"
- To change the setting, first select the control mode
- To set up output power or current, input desired value and click "Set". There are limits for max output per the model type.
- To turn on the Amplify click "Pump ON"; the green color should appear. To stop click "Pump OFF"; the red color should appear
- To save the setting click "Save Settings to Amplifier". The Amplifier will store the setting for the next time you turn it on, even without the PC.
- The Amplifier only works if the input optical power level is within the spec.

Erbium/Ytterbium Doped Fiber Amplifier

1528-1563nm & 1570-1603nm, up to 26dBm



DATASHEET

Control GUI

EDFA GUI V3.0

AGILTRON INC

Choose Device Model
EDFA-L

Connect to Amplifier
COM7 Refresh Disconnect

Monitor Status
Opt.IN: -0.34 dBm
Opt.Out: 15 dBm
BIAS-1: 417 mA
CoolCurr-1: 0 mA
LaserTemp-1: 26.2 °C
Modul Temp: 25.1 °C
PumpPower: 21.67 dBm
Power Voltage: 4.93 V
GAIN: 15.31 dB
ALARM: No Alarms
Model: EDFA-20dBm
SN: 220728001

Set Amplifier Parameters
Check Settings Pump ON Pump OFF
Control Mode: Power control Set Power(dBm) 15 Set Set Current(mA) 600 Set
Set Gain(dB) 23 Set

Command Log
Port connected
Get Sn/Model Success
Power Control Mode: Success
Check Settings: Success

Threshold settings
Module Temp Threshold: -5 - 55 °C Set
Pump Temp Threshold: 0 - 40 °C Set
Pump Current Threshold: 1200 mA Set
Input Power LOS Threshold: -33 dBm Set
Output Power LOS Threshold: -8 dBm Set
No Optical Power Threshold: -33 dBm Set

Erbium/Ytterbium Doped Fiber Amplifier

1528-1563nm & 1570-1603nm, up to 26dBm



DATASHEET

Output Power Stability (33dBm Benchtop)

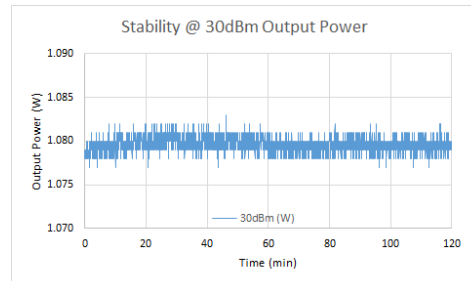
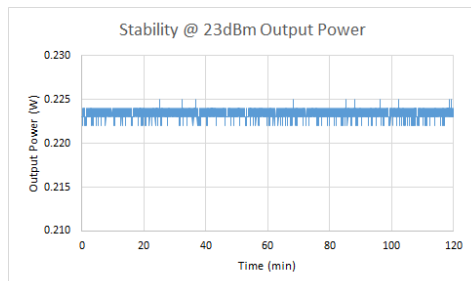
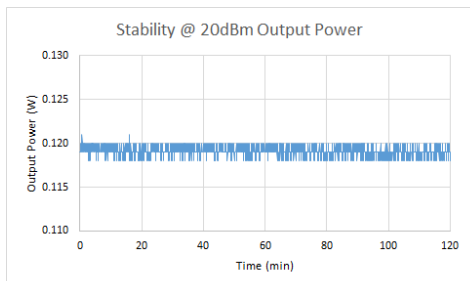

Mechanical Dimension (33dBm)

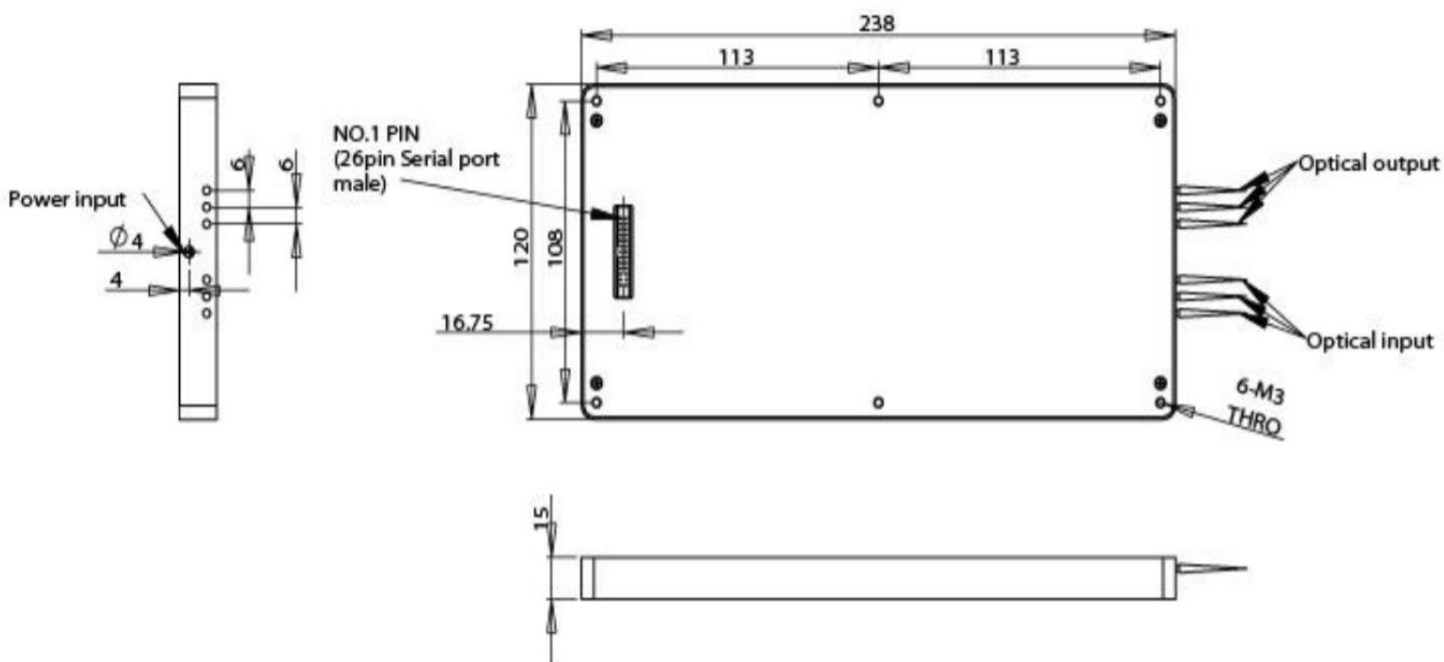

*Product dimensions may change without notice. This is sometimes required for non-standard specifications.

Erbium/Ytterbium Doped Fiber Amplifier

1528-1563nm & 1570-1603nm, up to 26dBm



DATASHEET

Mechanical Dimension

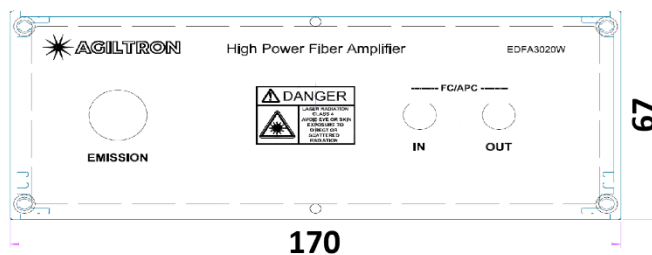
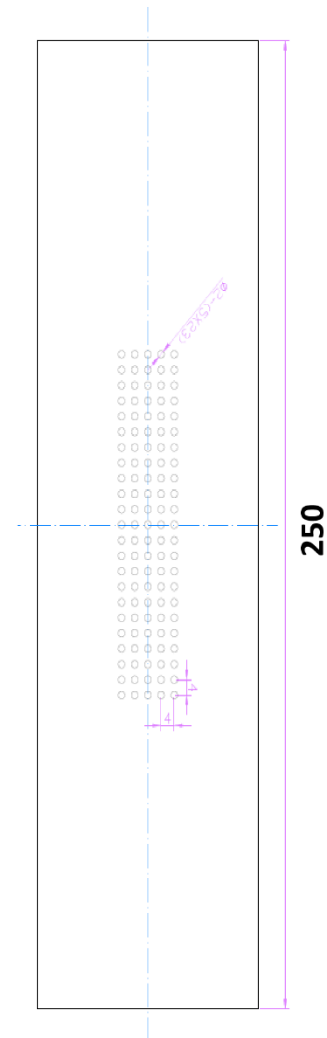
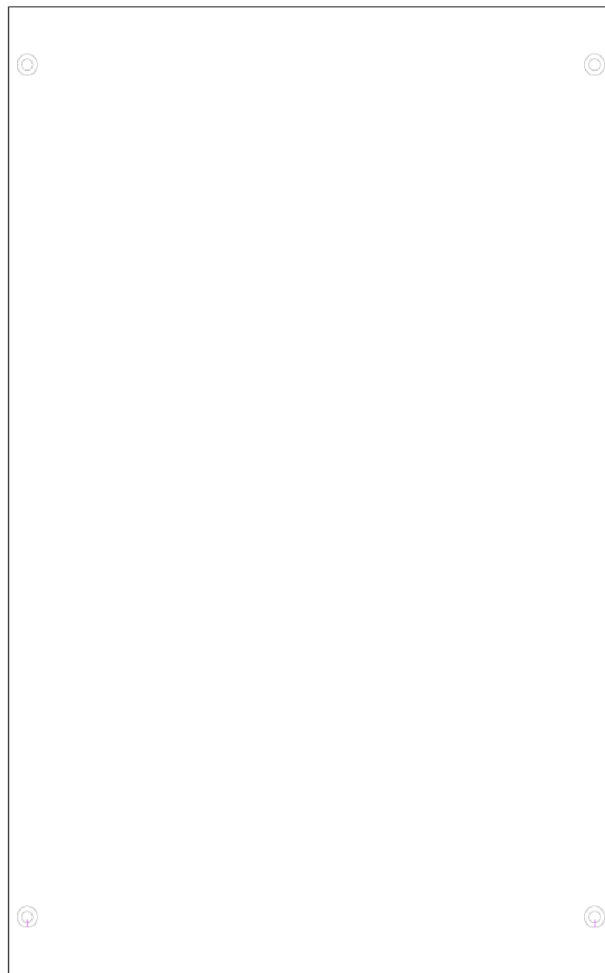

Small-size
Benchtop

*Product dimensions may change without notice. This is sometimes required for non-standard specifications.

Erbium/Ytterbium Doped Fiber Amplifier

1528-1563nm & 1570-1603nm, up to 26dBm



DATASHEET

Mechanical Dimension

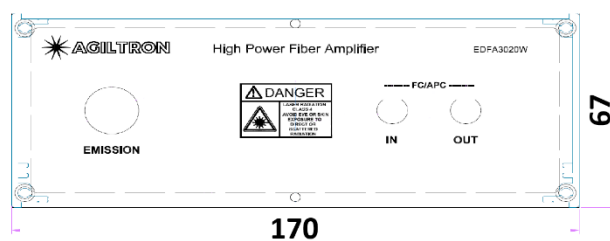
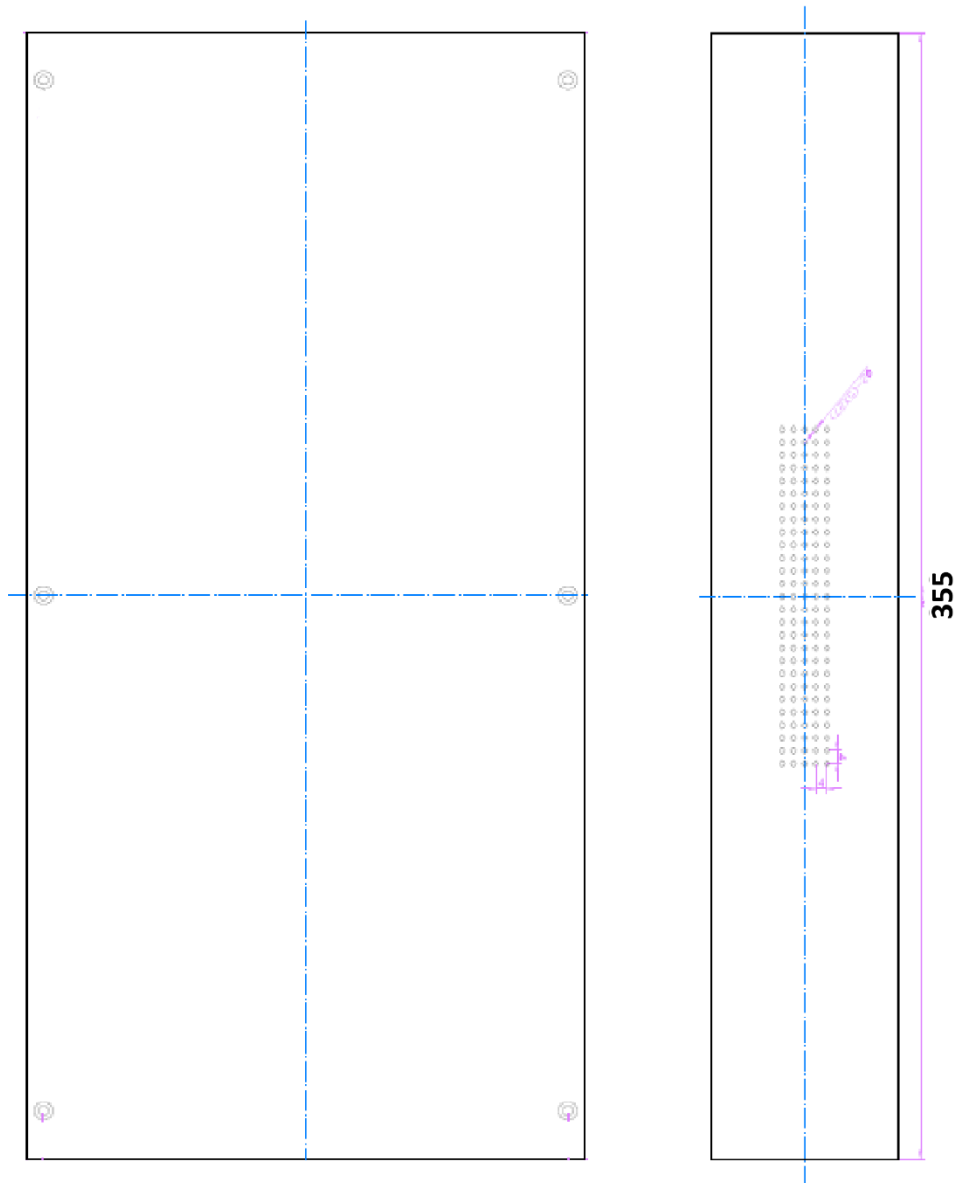

Mid-size
Benchtop

*Product dimensions may change without notice. This is sometimes required for non-standard specifications.

Erbium/Ytterbium Doped Fiber Amplifier

1528-1563nm & 1570-1603nm, up to 26dBm



DATASHEET

Ordering Information

Prefix	Type	Wavelength	Power	Polarization	Package	Cable Type	Fiber Length	Connector	Low Temperature	High Temperature
EYFA-	Booster = C Preamp = D	C+L = 1 Special = 0	15dBm/30mW = B 17dBm/50mW = 2 20dBm/100mW = 3 23dBm/200mW = D 25dBm/320mW = F 26dBm/400mW = G	Random = 1	Component = 1 Benchtop = 2 Pluggable = 3 Plug/Rack = 4	0.9mm tube= 3 Special = 0	0.25m = 1 0.5m = 2 1.0m = 3 Special = 0	None = 1 FC/PC = 2 FC/APC = 3 SC/PC = 4 Special = 0	-5°C = 1 -30°C = 2 Special = 0	50°C = 1 70°C = 2 Special = 0

[1]. For Booster, Power means maximum output power. For Preamp, Power means maximum amplification gain.

Application Notes

Fiber Core Alignment

Note that the minimum attenuation for these devices depends on excellent core-to-core alignment when the connectors are mated. This is crucial for shorter wavelengths with smaller fiber core diameters that can increase the loss of many decibels above the specification if they are not perfectly aligned. Different vendors' connectors may not mate well with each other, especially for angled APC.

Fiber Cleanliness

Fibers with smaller core diameters (<5 μm) must be kept extremely clean, contamination at fiber-fiber interfaces, combined with the high optical power density, can lead to significant optical damage. This type of damage usually requires re-polishing or replacement of the connector.

Maximum Optical Input Power

Due to their small fiber core diameters for short wavelength and high photon energies, the damage thresholds for device is substantially reduced than the common 1550nm fiber. To avoid damage to the exposed fiber end faces and internal components, the optical input power should never exceed 20 mW for wavelengths shorter 650nm. We produce a special version to increase the handling by expanding the core side at the fiber ends.

Erbium/Ytterbium Doped Fiber Amplifier

1528-1563nm & 1570-1603nm, up to 26dBm



DATASHEET

Laser Safety

This product meets the appropriate standard in Title 21 of the Code of Federal Regulations (CFR). FDA/CDRH Class 1M laser product. This device has been classified with the FDA/CDRH under accession number 0220191. All versions of this laser are Class 1M laser products, tested according to IEC 60825-1:2007 / EN 60825-1:2007. An additional warning for Class 1M laser products. For diverging beams, this warning shall state that viewing the laser output with certain optical instruments (for example eye loupes, magnifiers, and microscopes) within a distance of 100 mm may pose an eye hazard. For collimated beams, this warning shall state that viewing the laser output with certain instruments designed for use at a distance (for example telescopes and binoculars) may pose an eye hazard.

Wavelength = 1.3/1.5 μm .

Maximum power = 30 mW.



*Caution - Use of controls or adjustments or performance of procedures other than those specified herein may result in hazardous radiation exposure.

*IEC is a registered trademark of the International Electrotechnical Commission.

Q&A About Fiber Optical Amplifier

Q: Can this amplifier pulsed signals?

A: It has been tested to amplify up to 100GHz digital data.

Q: Can this amplifier WDM signals?

A: It has been tested to amplify signals with DWDM wavelength spacing.

Q: Can this amplifier has a flat wavelength response?

A: Yes, by put fluttering gain filters, that is an extra cost.

Q: If one puts a small signal into it, can it be amplified to the maximum output power indicated on the spec?

A: The amplifier is set as an analog mode whose output signal strength is approximately proportional to the input strength. It has a certain gain of about 40dB. There are two types: one is a preamplifier and a booster. One can use a preamplifier before the booster for weak signals, as done in electronic amplifiers.

Q: We have an existing amplifier. Can you duplicate it?

A: Yes, we can produce it with a seamless software interface.

Erbium/Ytterbium Doped Fiber Amplifier

1528-1563nm & 1570-1603nm, up to 26dBm



DATASHEET

Modes Description

The EDFAs have both ACC mode - automatic current control or constant current control and APC mode - automatic power control settable via GUI. In the ACC mode, the pump laser's current is set by the user and automatically locked by the EDFA to achieve a constant pumping current. The EDFA's output power is proportional to the input power and has output even though the input signal is weak. In the APC mode, the user sets the output power, and the EDFA automatically maintains the output constant in a feedback laser pump control way. When the input optical power fluctuates, the APC mode minimizes the fluctuation of the output power and is suitable for power type and line type EDFA.

Typical Spectrums

Gain vs. Wavelength

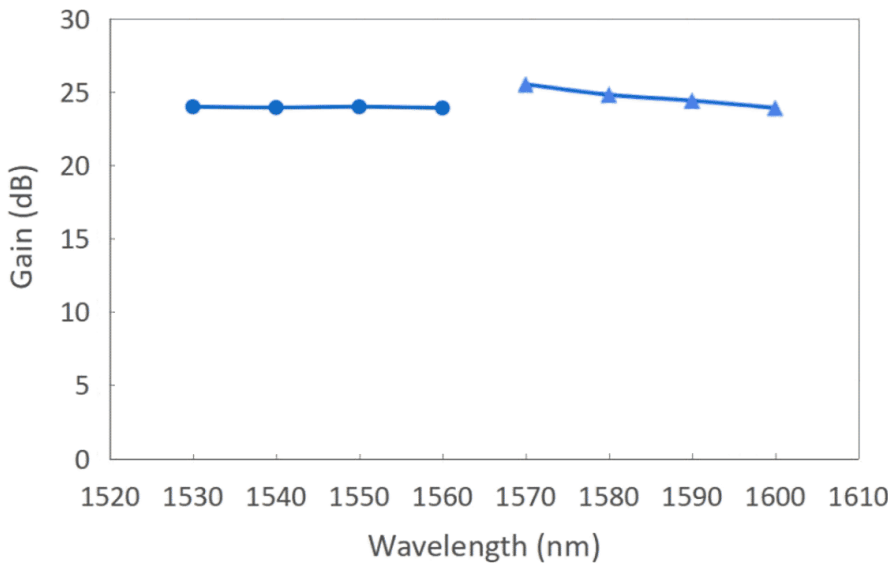

Noise Figure vs. Wavelength

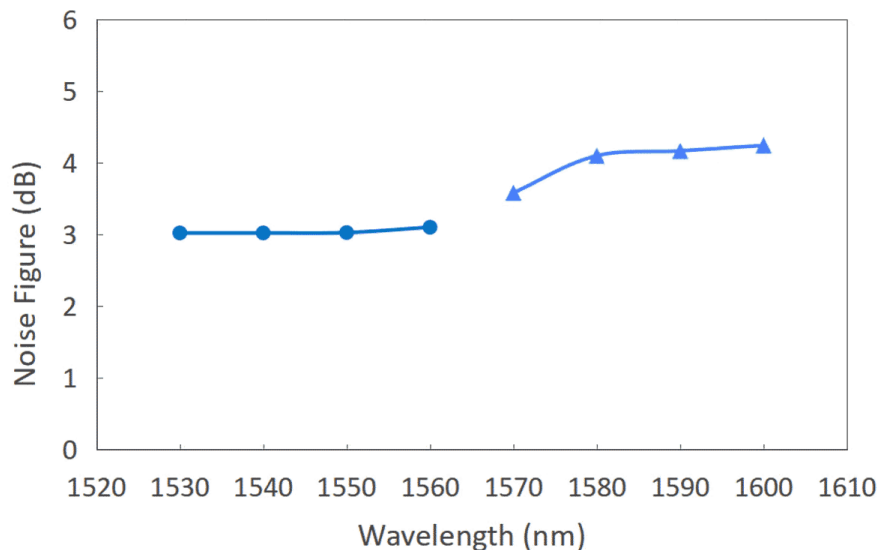

Erbium/Ytterbium Doped Fiber Amplifier

1528-1563nm & 1570-1603nm, up to 26dBm



DATASHEET

Power Gain

